

# TheKickPlateStore

## Anodized Aluminum Kick Plate

### 32" x 34"

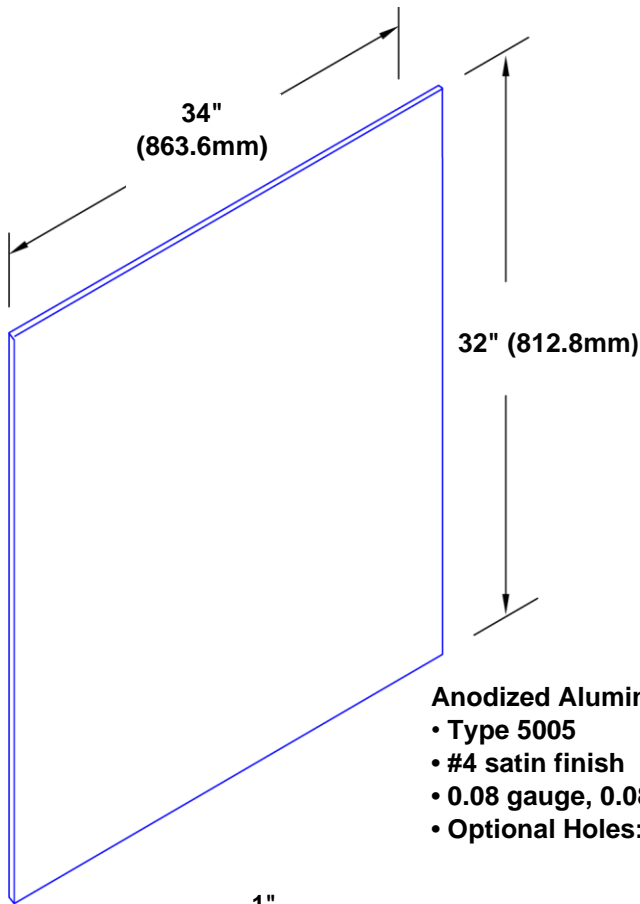

#### Features:

- Custom sizes Available
- Type

#### Finishes:

- Brushed #4
- Mirror Polished #8 optional

#### Mounting Options:

- Adhesive:
  - Construction adhesive supplied separate
- Drilled:
  - Clearance holes for 1/8" #8 fastener wood screw
- Magnetic:
  - Metal doors only

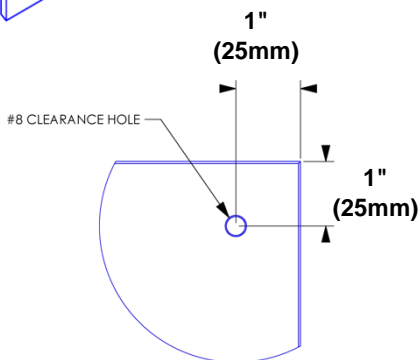

#### Beveled Edge Option

Includes chamfered left, top and right edges custom configurations of beveled edges are available upon request.

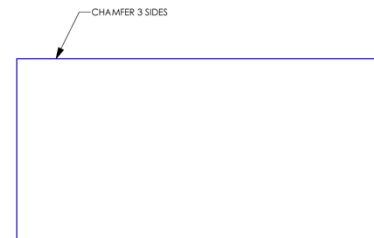

#### Elevation



#### Section At Beveled Edge

#### Optional Beveling

# of Holes	Kick Plate Size
6	6x24 to 16x24
8	24x24, 6x32 to 16x32, 6x48 to 16x48
10	24x32 to 24x48, 24x32, 24x48
12	32x32 to 48x48

Dimensions are specified as Width x Height

#### Optional Drilling