

# TheKickPlateStore

## Anodized Aluminum Kick Plate

### 12" x 30"

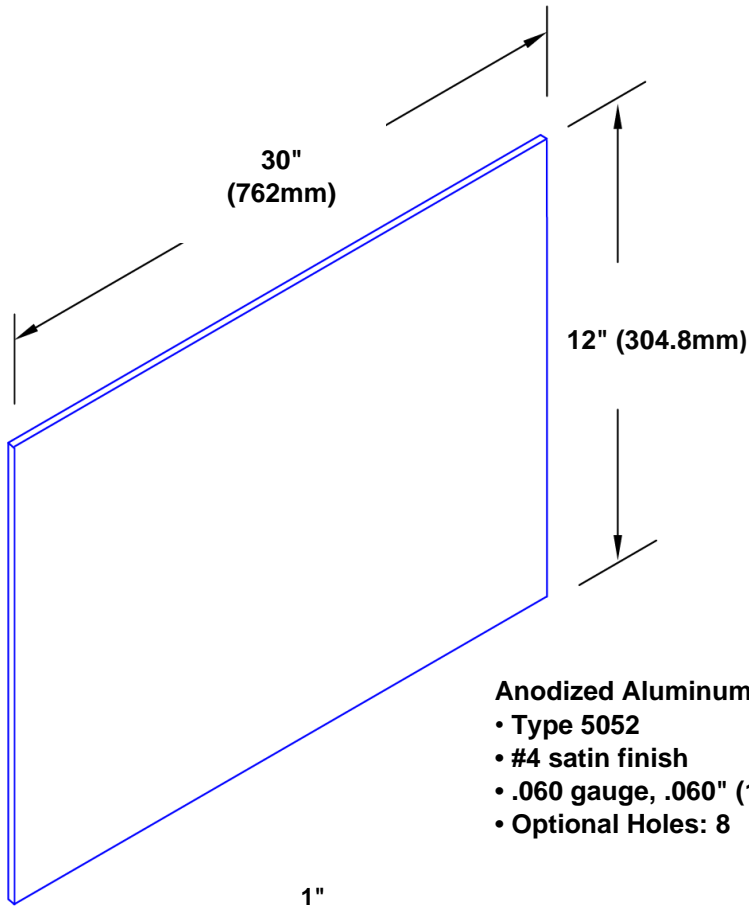

- Anodized Aluminum**
- Type 5052
  - #4 satin finish
  - .060 gauge, .060" (1.524mm)
  - Optional Holes: 8



**Features:**

- Custom sizes Available
- Type

**Finishes:**

- Brushed #4
- Mirror Polished #8 optional

**Mounting Options:**

- Adhesive:
  - Construction adhesive supplied separate
- Drilled:
  - Clearance holes for 1/8" #8 fastener wood screw
- Magnetic:
  - Metal doors only

**Beveled Edge Option**

Includes chamfered left, top and right edges custom configurations of beveled edges are available upon request.

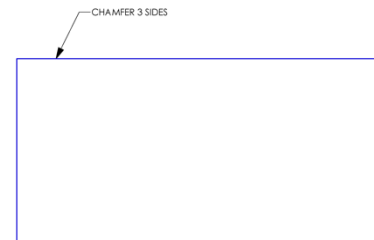

**Elevation**



**Section At Beveled Edge**

**Optional Beveling**

# of Holes	Kick Plate Size
6	6x24 to 16x24
8	24x24, 6x32 to 16x32, 6x48 to 16x48
10	24x32 to 24x48, 24x32, 24x48
12	32x32 to 48x48

Dimensions are specified as Width x Height

**Optional Drilling**