

TheKickPlateStore

Anodized Aluminum Kick Plate

10" x 28"

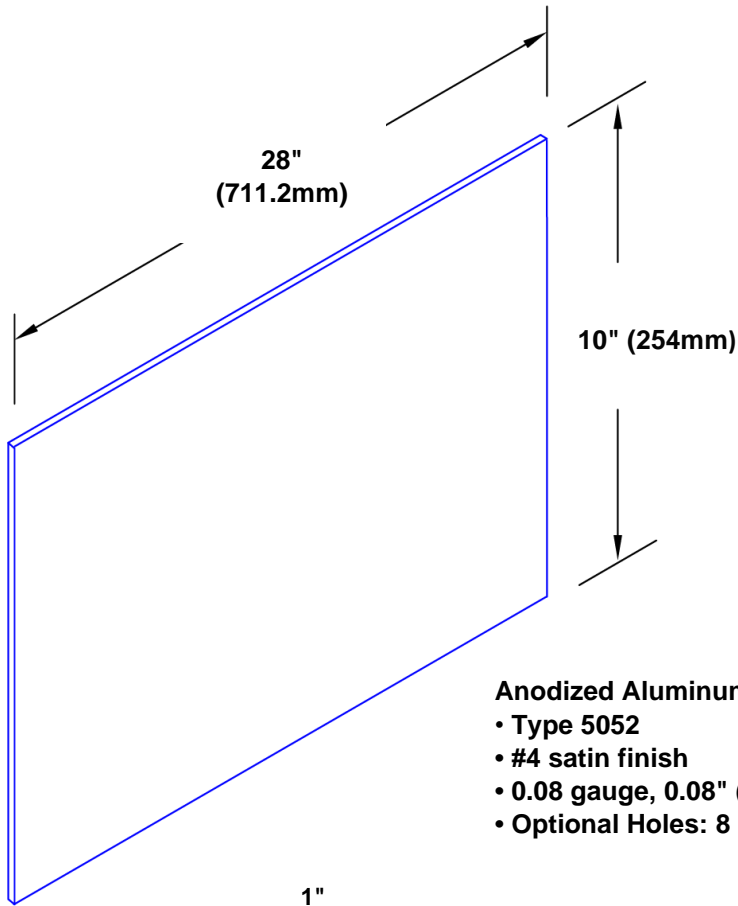

- Anodized Aluminum**
- Type 5052
 - #4 satin finish
 - 0.08 gauge, 0.08" (1.016mm)
 - Optional Holes: 8



Features:

- Custom sizes Available
- Type

Finishes:

- Brushed #4
- Mirror Polished #8 optional

Mounting Options:

- Adhesive:
 - Construction adhesive supplied separate
- Drilled:
 - Clearance holes for 1/8" #8 fastener wood screw
- Magnetic:
 - Metal doors only

Beveled Edge Option

Includes chamfered left, top and right edges custom configurations of beveled edges are available upon request.

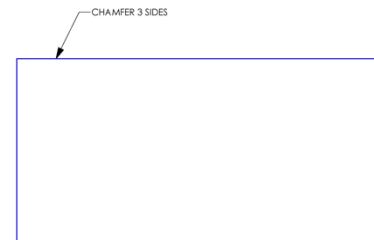

Elevation



Section At Beveled Edge

Optional Beveling

# of Holes	Kick Plate Size
6	6x24 to 16x24
8	24x24, 6x32 to 16x32, 6x48 to 16x48
10	24x32 to 24x48, 24x32, 24x48
12	32x32 to 48x48

Dimensions are specified as Width x Height

Optional Drilling