

# TheKickPlateStore

## Polycarbonate Kick Plate

### 12" x 32"

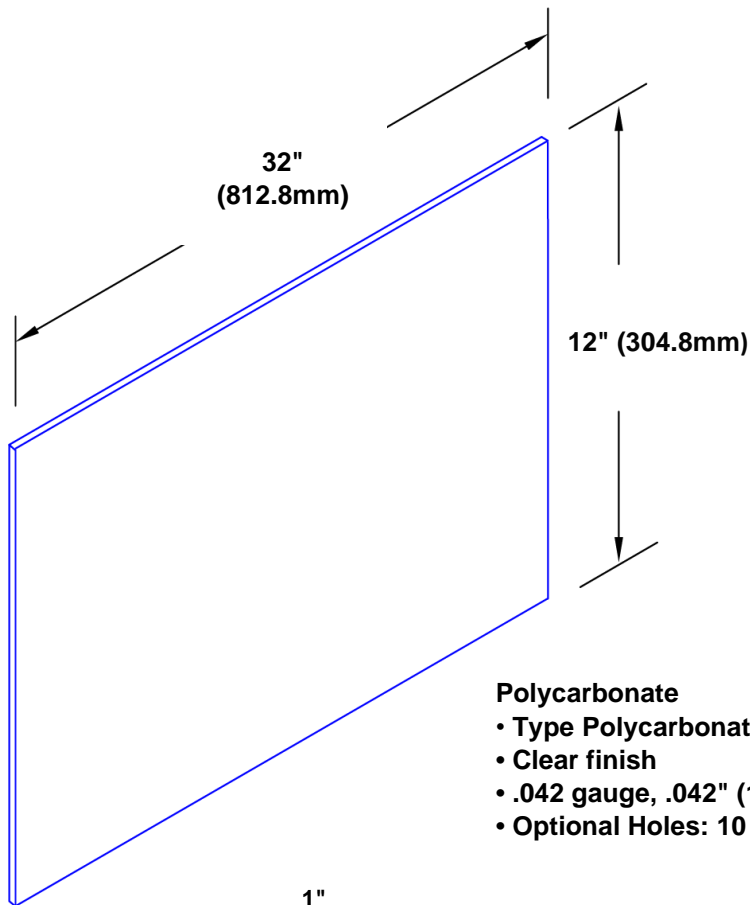

# of Holes	Kick Plate Size
6	6x24 to 16x24
8	24x24, 6x32 to 16x32, 6x48 to 16x48
10	24x32 to 24x48, 24x32, 24x48
12	32x32 to 48x48

Dimensions are specified as Width x Height

### Optional Drilling

### Features:

- Custom sizes Available
- Type

### Finishes:

- Brushed #4
- Mirror Polished #8 optional

### Mounting Options:

- Adhesive:
  - Construction adhesive supplied separate
- Drilled:
  - Clearance holes for 1/8" #8 fastener wood screw
- Magnetic:
  - Metal doors only

### Beveled Edge Option

Includes chamfered left, top and right edges custom configurations of beveled edges are available upon request.



Section At Beveled Edge

### Optional Beveling